SUPER WHITE LARGE

Design by

Thomas Housden

Material & Style

Earthenware & White Glaze

Dimensions & Weight

Ø350mm H320mm

6Kg

Lamp Type & Wattage

E27 lamp Max 12W LED Bulb (not included)

E26 lamp Max 12W LED Bulb (USA)

Dimmable (if used with compatible dimming controls and bulbs)

IP

IP20

Wiring Standard

CE - EN 60598

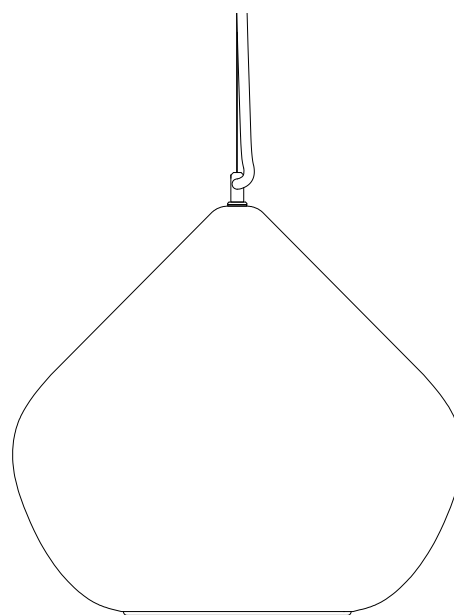

Hand & Eye Studio

Purple Studio
Old Paradise Yard
20 Carlisle Lane
London
SE17LG

T +44 (0)1252 715646

info@handandeyestudio.co.uk

SAFETY NOTES



1 During installation:

- Please read the instructions before assembly or installation.
- Be sure to use a suitably qualified person for installation as the lights require connecting to mains power
- Make sure mains power is off during installation
- Make sure that the light is securely hung from the ceiling and that there is a suitable substrate for this. The weight of the lamp needs to be taken by the suspension wire not the electrical flex.
- When attaching the ceiling rose ensure you are working from a safe platform or ladder
- Do NOT use an electric screwdriver to tighten the ceiling rose screws as this can cause it to crack

2 Once installed:

- Do NOT use a light bulb of more than 12W
 - We strongly recommend using an LED light bulb and we recommend an opal bulb.
 - Take care with the ceramic shade as this can break if hit hard enough. We recommend installing the lamp above furniture such as tables or island units or above head height.
 - If at any point your light bulb breaks then, as with any light, do not touch the filament/LED part unless the power is turned off
 - Always turn off the power before changing a light bulb
-

DIAGRAM 1
Lamp Components

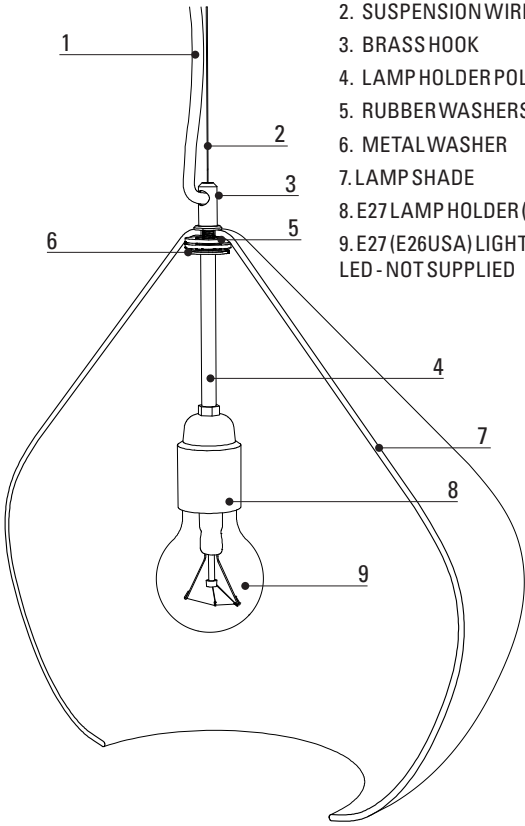

1. ELECTRIC FLEX WITH WOVEN FABRIC SHEATHING
2. SUSPENSION WIRE
3. BRASS HOOK
4. LAMP HOLDER POLE
5. RUBBER WASHERS
6. METAL WASHER
7. LAMP SHADE
8. E27 LAMP HOLDER (E26 USA)
9. E27 (E26 USA) LIGHT BULB MAX 12W LED - NOT SUPPLIED

Shade and flex assembly (diagram 1)

- If the lamp has arrived fully assembled (as in diagram 1) then proceed to the next section. If not:
- Thread the metal washer (6) over the flex (1) and onto the threaded part of the lamp holder (4). Then repeat this with the rubber washers (5) which should sit between the metal washers and ceramic shade.
 - Thread the wire cable (2) through the threaded base opening of the brass hook (3) and up through the small hole at the top. The ball on the wire should end up sitting just at the top of the hook inside.
 - Thread the flex (1) through the hole in the ceramic shade (7) and position the lamp holder (4) so the thread is sticking through the hole. Feed the flex (1) through the threaded base opening of the brass hook (3) and out of the side hole. Continue to feed through until the brass hook meets the threaded pole at the ceramic shade, take care that the fabric does not get snagged.
 - Screw the brass hook (3) onto the threaded pole of the lamp holder (4).

DIAGRAM 2
Ceiling Rose Components

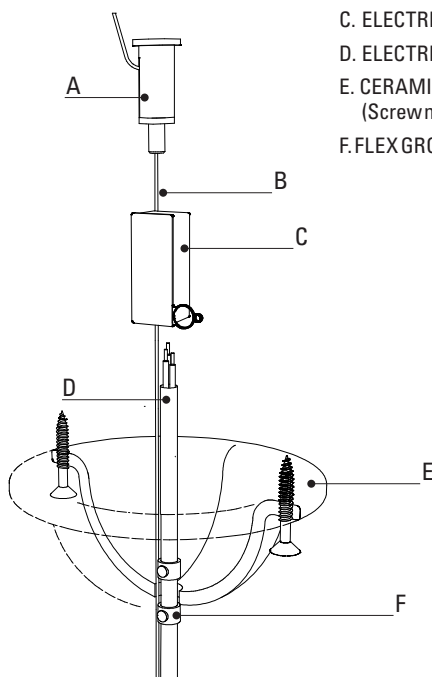

- A. CEILING FIXING COMPONENT/WIRE CLAMP (Screw not supplied)
- B. SUSPENSION WIRE
- C. ELECTRICAL JUNCTION BOX
- D. ELECTRICAL FLEX
- E. CERAMIC CEILING ROSE (Screw not supplied)
- F. FLEX GROMMET

Hanging the light (diagram 2 and 3)

- Thread a flex grommet (F) over the wire cable (B) and flex (A) (if you wish to keep the flex close to the wire or create a swagging effect).
- Thread the flex and wire cable through the hole in the ceiling rose (E). Thread another flex grommet (F) over the flex and wire cable to sit inside the ceiling rose (this can later be tightened to clamp the flex).

- Assess the ceiling fixing point. The lamp should be hung from a suitable substrate or joist in the ceiling. The screw fixing is not provided and must be selected to suit the ceiling build up. If fixing to a plasterboard ceiling with no joist use a heavy duty expanding metal fixing. If fixing to a timber joist use a timber screw of 5 mm diameter. If fixing to masonry use a suitable masonry screw and raw plug. We strongly recommend the use of a professional electrician or tradesman.

- Take the top part of the ceiling attachment (G), which may need to be unscrewed from the bottom part (I), and screw this into the ceiling joist (screw not supplied).
- Thread the wire cable through the bottom part of the ceiling attachment. To do this unscrew the small clamp (J) at the bottom and push the cable through the hole. This will automatically clamp the cable so that you can push it in but it will not pull out. In order to pull the cable back out, simply push the clamp in as you pull the cable.
- Screw the bottom part (I) into the top part (G) attached to the ceiling (the cable can stick out of the side as shown in diagram 3B).

DIAGRAM 3A
Ceiling Attachment Components

- G. TOP PART OF CEILING ATTACHMENT
- H. SCREW (NOT SUPPLIED)
- I. BOTTOM PART OF CEILING ATTACHMENT
- J. CLAMP

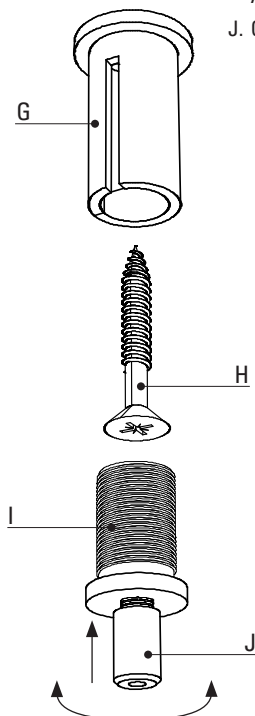
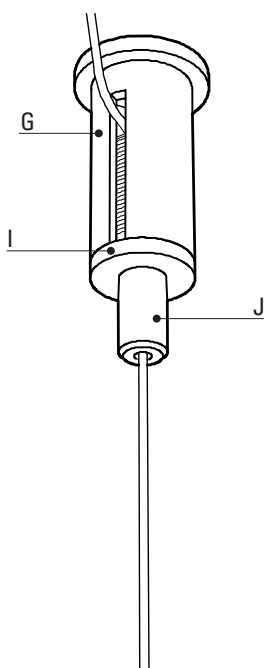

DIAGRAM 3B
Ceiling Attachment Assembled



- At this point the length of the cable can be decided by pushing/pulling the cable through the clamp. Once you are happy with the length of the cable, screw the clamp (J) so it is closed (fully securing the wire cable) and cut any excess cable off carefully.

Connecting the electrics (diagram 2)

- We recommend that you use a qualified electrician to connect the electrics. Make sure electricity is turned off at the mains during installation.
- Decide on the length of flex required and, if necessary, cut the flex to the desired length (use electrical tape so it does not fray)
- Connect the lamp flex (D) to the mains electric cables using the connector block (C) make sure the block is securely fastened around the outer cable.
- Clamp the flex with the previously installed flex grommet (F) to set the flex length.

Attaching the ceiling rose (diagram 2)

- Cover the fixings with the ceiling rose (E) and fasten this to the ceiling using two small screws (not supplied, we recommend using dome head brass screws).
- Do NOT use an electric screwdriver as this can cause the rose to crack.
- No weight should be by the ceiling rose.
- The ceiling rose will not cover an existing plastic / metal ceiling rose, this would need to be removed.

Installing a light bulb

- Install your light bulb into the lamp holder (5), taking care not to apply too much sideways force to the pole (3).
- Use an LED light bulb, max 12W. See website product info for light bulb recommendations.

Hand&Eye II Super White

 This luminaire is compatible with bulbs of the energy classes:

A⁺⁺
A⁺
A
B
C
D
E



874/2012 